

INGENIEURSGRAFIKA EN
-ONTWERP

VRAESTEL 2

MEMORANDUM

GR 12

SEPTEMBER 2013



ANTWOORDE		
1	20/04/2013	1
2	GIETYSER	1
3	ROT/CAD	1
4	EEN	1
5	± 0,25	1
6	GEDEELTELIKE ARSERING	1
7	S-SNIT	1
8	SLEGS GEDEELTE VAN TEKENING GETEKEN	1
9	TOTALE AFSTAND AANGETOON, HOEWEL KORTER GETEKEN	1
10	Ø198	1
11	141	1
12		4
13		4
14		5
	TOTAAL	24

ANTWOORD 12

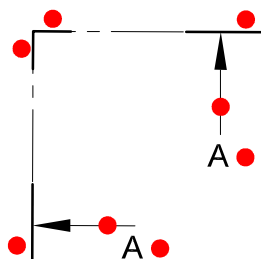

ANTWOORD 13

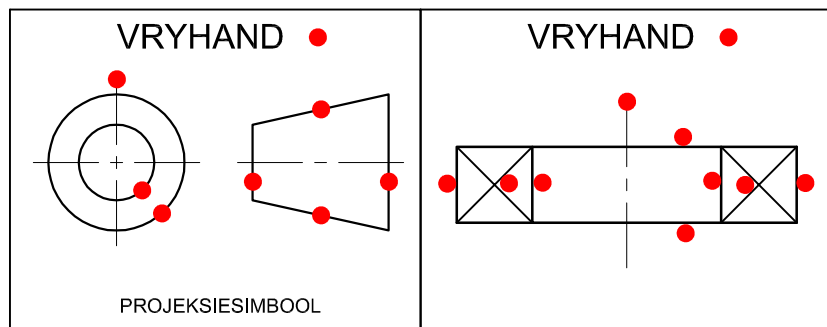

ANTWOORD 14

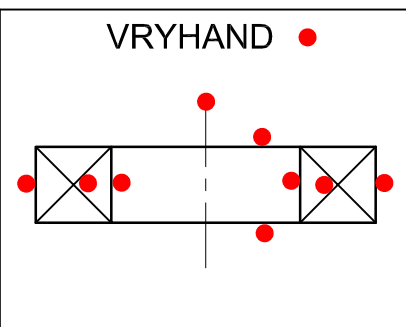

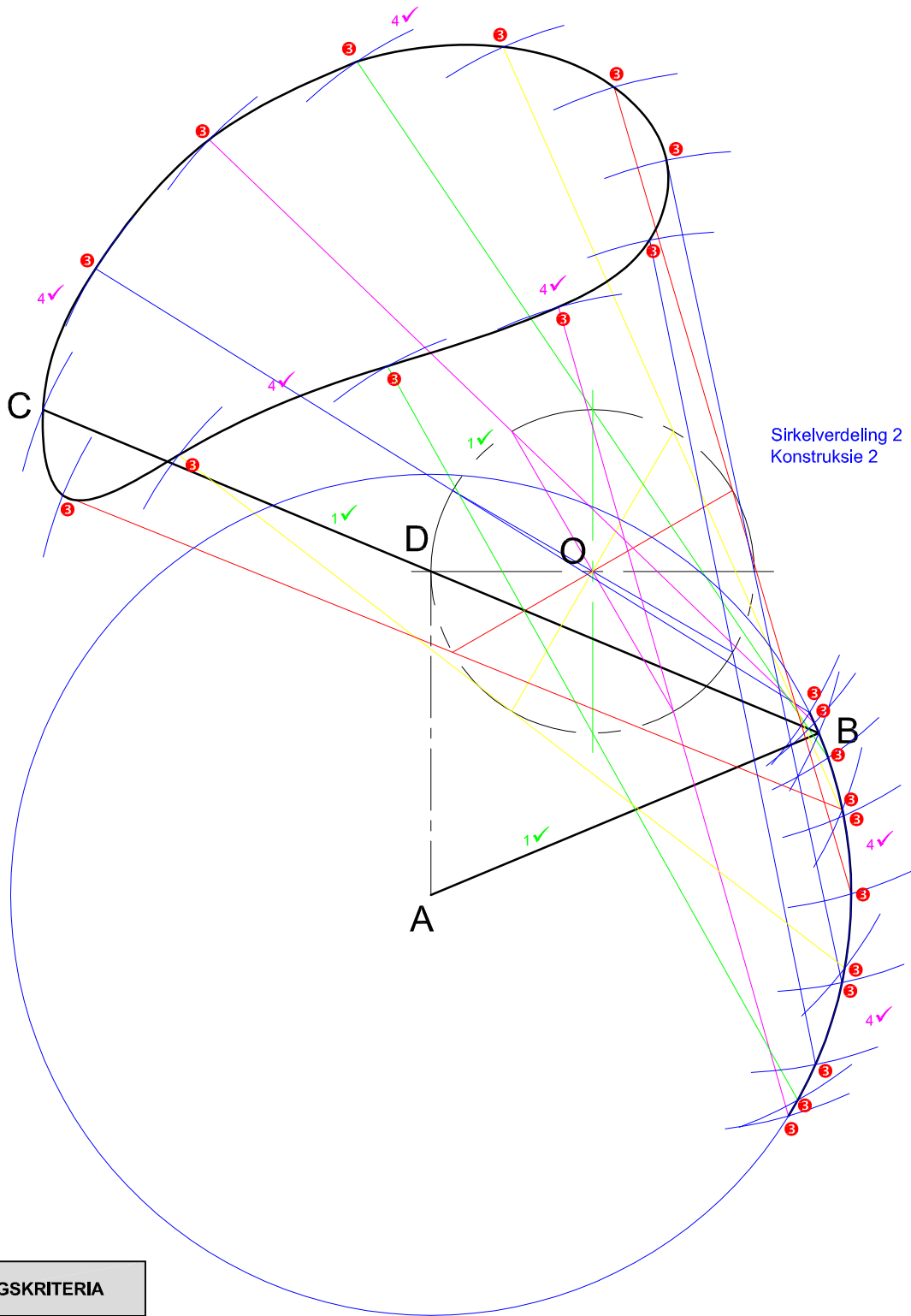

ASSESSERINGSKRITERIA	
1. KOPIEËR	3
2. KONSTRUKSIE	4
3. PUNTE	11
4. KURWE	6
TOTAAL	24

VRAESTEL 2 VRAAG 2.1
 GRAAD 12
 SEPTEMBER 2013
 MEMORANDUM

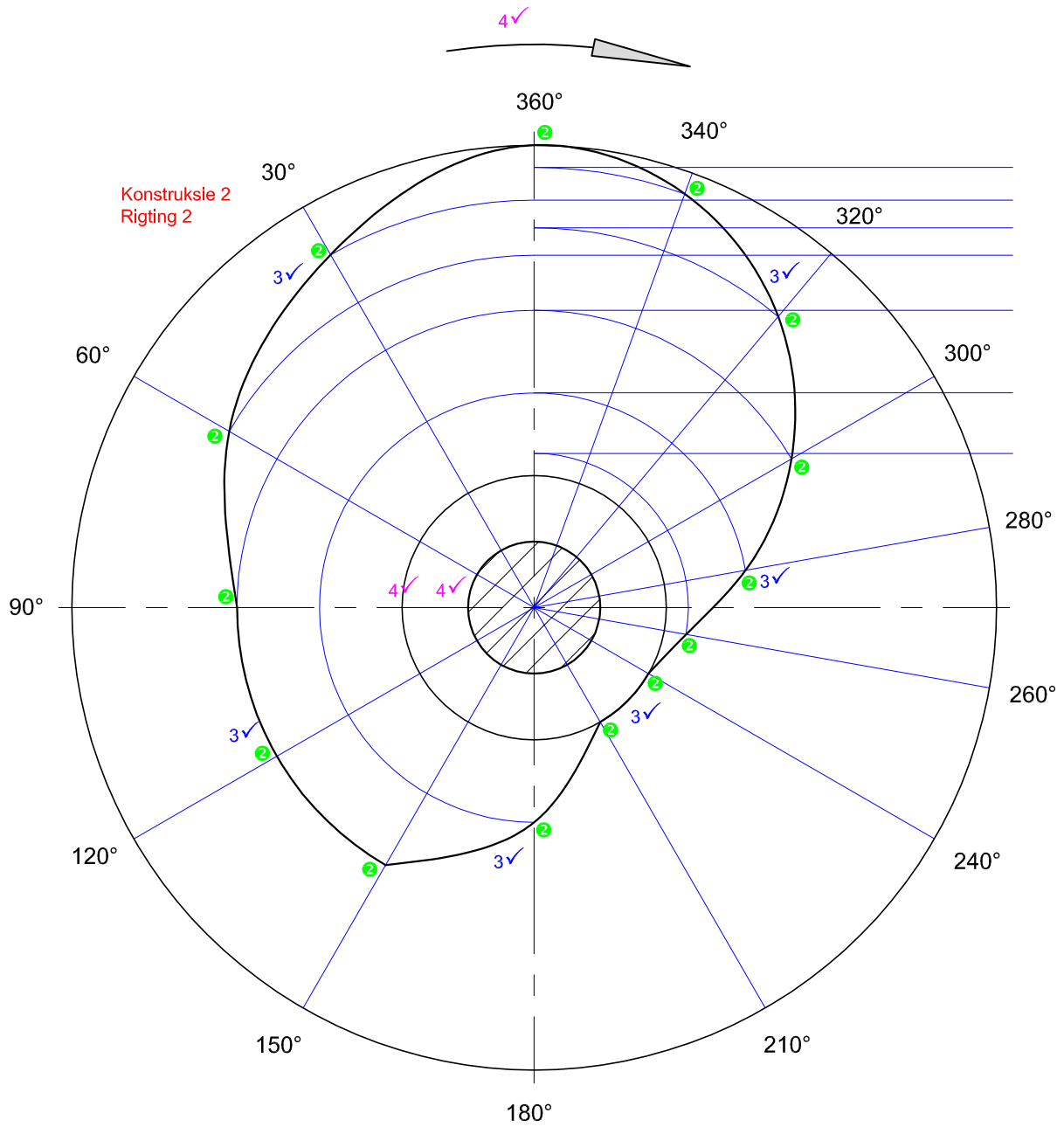

ASSESSERINGSKRITERIA	
1. KONSTR & RIGTING	4
2. PUNTE	7
3. KURWE	6
4. AS, MIN RADIUS & PYL	3
5. BYSKRIFTE	2
TOTAAL	22

VRAESTEL 2 VRAAG 2.2
 GRAAD 12
 SEPTEMBER 2013
 MEMORANDUM

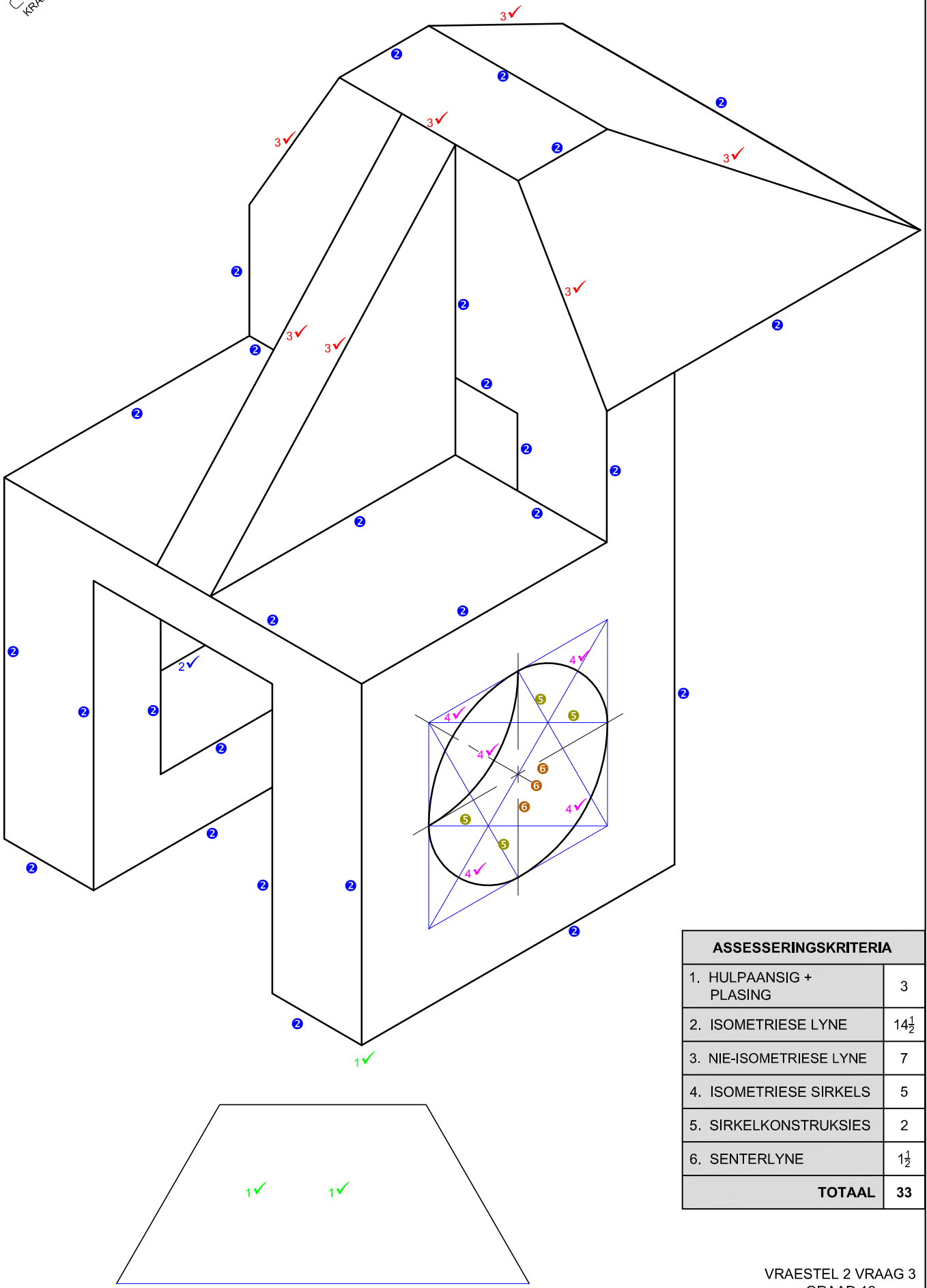

ASSESSERINGSKRITERIA	
1. HULPAANSIG + PLASING	3
2. ISOMETRIESE LYNE	14½
3. NIE-ISOMETRIESE LYNE	7
4. ISOMETRIESE SIRKELS	5
5. SIRKELKONSTRUKSIES	2
6. SENTERLYNE	1½
TOTAAL	33

VRAESTEL 2 VRAAG 3
 GRAAD 12
 SEPTEMBER 2013
 MEMORANDUM



ASSESSERINGSKRITERIA	
DEURSNEE VOORAANSIG	
1. BASIS	15
2. KEERRING	2½
3. BOUT	8½
4. BUS	2½
5. KATROL	17
6. AS	7
7. BUS	1
8. SPASIEERDER	2
9. WASTER	1½
10. M16-MOER	5
11. SENTERLYNE	3
SUBTOTAAL	65

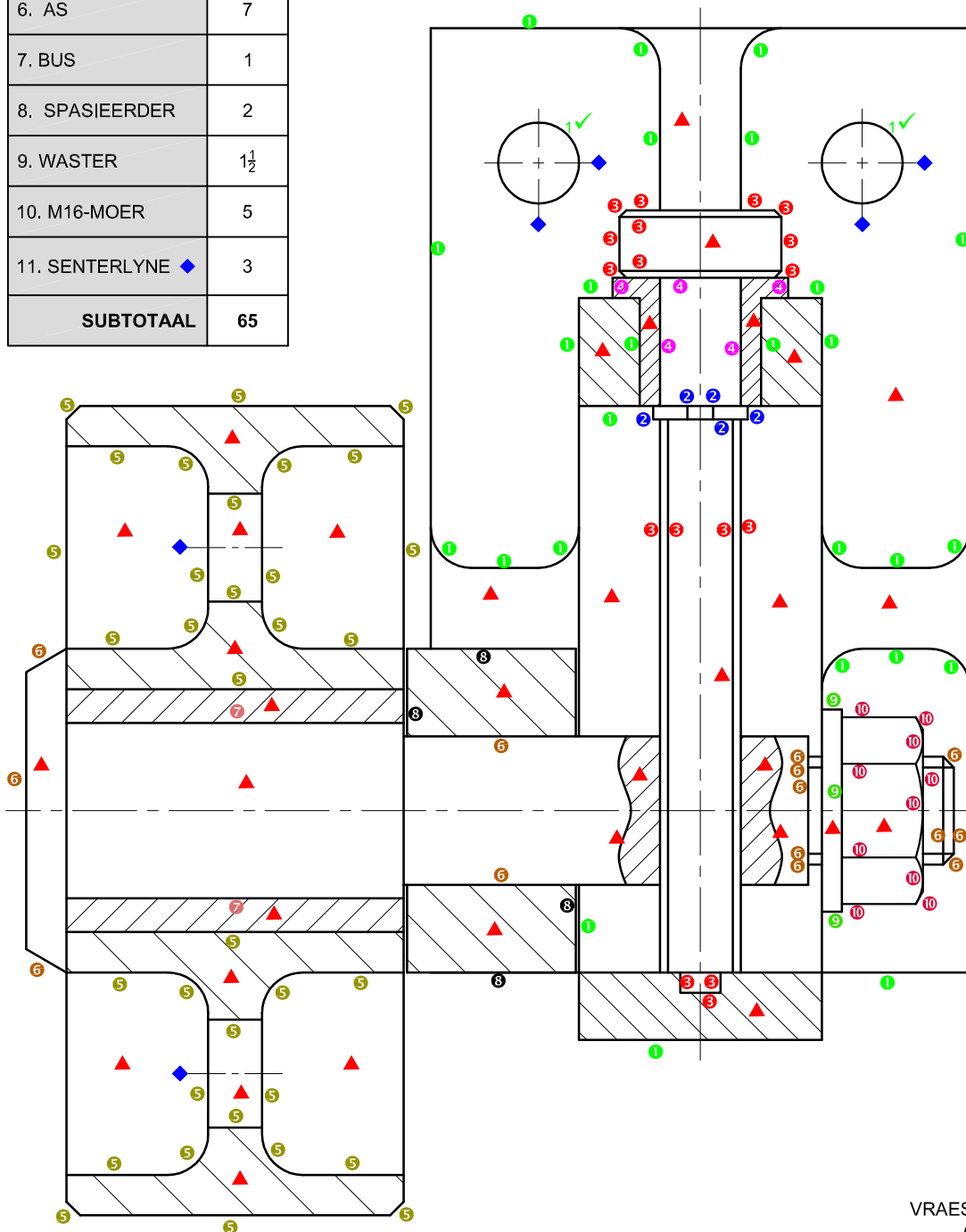

VRAESTEL 2 VRAAG 4
 GRAAD 12
 SEPTEMBER 2013
 MEMORANDUM



ASSESSERINGSKRITERIA	
REGTERAANSIG	
1. BASIS	
2. KEERRING	
3. BOUT	5
4. BUS	1½
5. KATROL	
6. AS	2½
7. BUS	
8. SPASIEERDER	
9. WASTER	1
10. M16-MOER	4
11. ARSERING ▲	18
SUBTOTAAL	32
TOTAAL	97

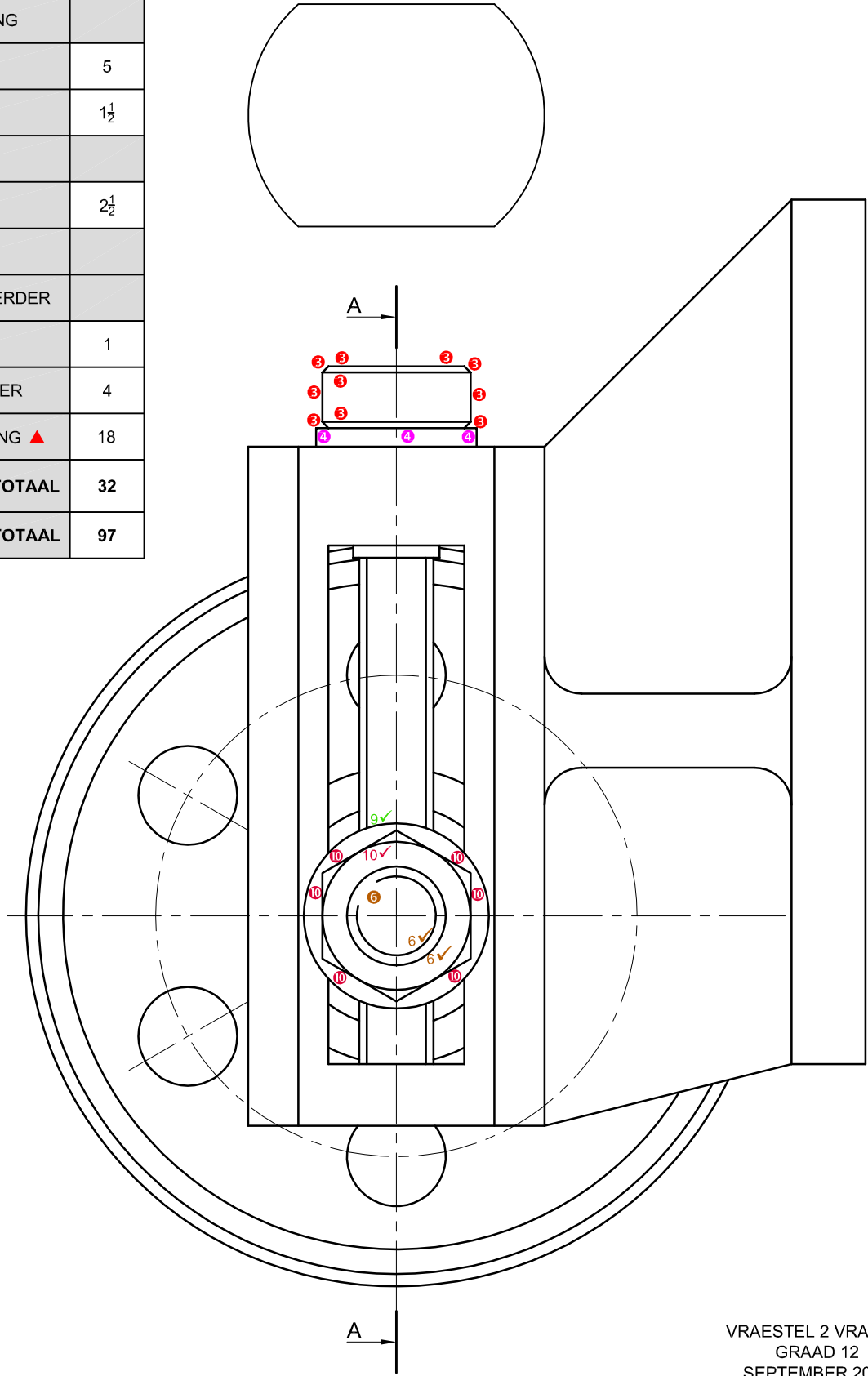

VRAESTEL 2 VRAAG 4
 GRAAD 12
 SEPTEMBER 2013
 MEMORANDUM